

CRYSTALTECH™ Treated Glass

Model: AQ-1370-BL-L-R

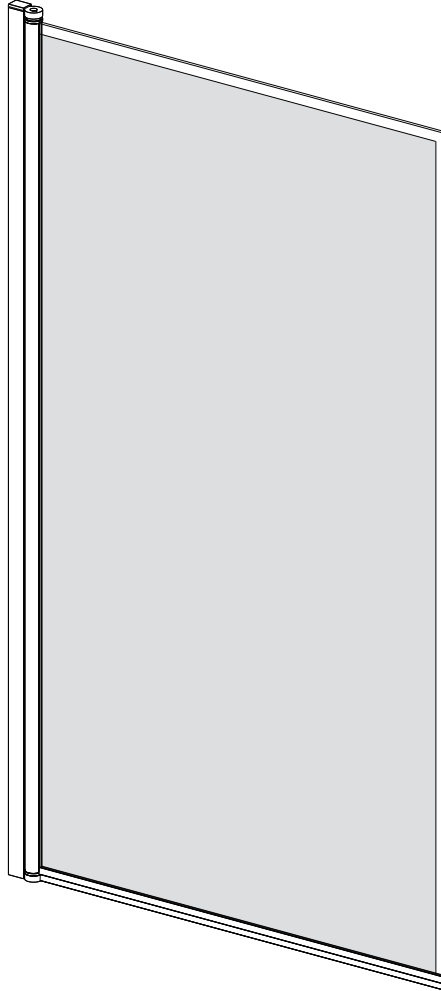

Reversible for a Left or Right Door Installation



**READ ENTIRE INSTALLATION
GUIDE PRIOR TO INSTALLING
THE SHOWER DOOR**

SCAN FOR

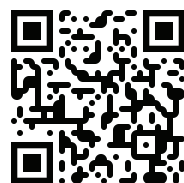

YouTube Channel

TABLE OF CONTENTS

1.	Prior To Installation	3
2.	Tools Required	7
3.	Parts Diagram	8
4.	Installation	10
5.	Product Care	16
6.	Warranty	20

1. Prior To Installation

To Our Valued Customers,

We wanted to take a moment to express our sincere gratitude for choosing our shower door for your bathroom. Your recent purchase is greatly appreciated, and we are delighted to have you as our valued customer.

At Streamline, we strive to provide the highest quality products, and we are confident that our shower door will exceed your expectations in terms of both functionality and style. We have put in great effort to ensure that our shower door enhances your bathing experience while adding an elegant touch to your bathroom.

We would like to assure you that our dedicated team is always here to assist you with any questions or concerns you may have regarding the installation or maintenance of your new shower door. Your satisfaction is our top priority, and we are committed to delivering excellent customer service throughout your journey with us.

Once again, we genuinely appreciate your trust in our brand and your decision to choose our shower door. We hope it brings you years of enjoyment and satisfaction. If there is anything we can do to further assist you, please do not hesitate to reach out to us.

Thank you for being a valued customer.

Warm regards,

The Streamline Team

- All Streamline shower doors are tested extensively by third parties to meet the following US, Canadian, and International Standards:
 - ANSI Z97.1-2005 Class A
 - CPSC 16 CFR 1201 II
 - CAN/CGSB 12.1-2017
- Prior to handling or installing this shower door, it is crucial to thoroughly review the following safety information, as there is a significant risk of severe injury. All instructions **MUST** be followed for safe installation.
- Before commencing the installation process, carefully inspect all boxes and packages for any shipping damages. Once you've opened all the boxes, read the instructions thoroughly, and ensure all the necessary components are included in the package. If any parts are missing or damaged, please immediately reach out to our customer support team at 310-935-0028 or via email at support@streamlinebath.com
- Inspect the glass. Check closely to see if there are any scuffs, scratches, or chips. If the glass is damaged, it's imperative not to install or operate if the glass panels display chipped corners, slivered edges, or any other visual defects. Contact Streamline immediately for product support. Streamline is not responsible for any product liability or damage if the product is continued to be installed in its damaged state.
- This product should be installed by two people.
- It is important to regularly check the glass and all parts of the shower door and side panels for damage and missing/loose components.
- Not adhering to the recommended instructions and installation techniques may result in potential harm to the unit, its surroundings, or pose a risk of severe personal injury. Such actions can impact warranty claims as well.
- This product is intended for residential use only.
- The warranty on this product will be invalidated if any changes or deviations are made from the instructions provided in the manual. Streamline will not be held accountable for any harm to the unit or personal belongings resulting from incorrect installation.
- It is highly recommended to use professional-grade glass suction cups when handling glass doors.
- Please do not install the handle onto the glass door until instructed to do so. It is important never to use the handle to lift the glass as this may cause serious personal injury and damage to the glass.

- To prevent the glass from shattering, it is crucial to follow all installation instructions carefully. Improper installation can lead to breakage.
- Professional installation is required. The professional installer, who should be licensed and bonded, is responsible for ensuring the safety and integrity of the shower door installation and should have familiarity and experience with such installation.
- Avoid leaning or pushing against glass doors to prevent any risk of breakage or injury.
- Always wear safety glasses and gloves while handling glass and/or drilling holes. We recommend wearing non-slip gloves.
- While installing, ensure that corner protectors remain on the glass to minimize the risk of breakage. The corners of the glass doors are most prone to damage.
- Ensure that all surfaces are level, most importantly, the threshold for the shower door. An uneven surface, walls that are not properly plumb, lower round corners, etc., can lead to significant installation issues.
- Always follow the provided installation instructions.
- Improper installation of any of the components of the shower door (glass, rollers, hardware, etc.) can cause the product to fail.
- During installation, it is essential to exercise extreme caution when handling the glass, as tempered glass may break if it comes into contact with a hard surface.
- To avoid shattering, it's important to refrain from cutting or altering tempered glass.
- Building and plumbing codes may vary state-to-state. We are not responsible for any local code compliance for this product. Consult with a professional.
- Streamline shall not be held liable for any and all incidental damage or flood caused due to the use of this product.
- No modifications to the product outside of the scope of the installation instructions are allowed.
- Streamline shall not be held liable for any and all fees stemming from the cost of installation, re-installation, removal, subsequent damage, or transportation in the case of a product defect. Streamline shall not be held responsible for defects or damage that could have been discovered, repaired, or avoided by inspection and testing prior to installation. The shower base must be checked upon delivery.

- Make sure to test all plumbing connections as well as check for leaks prior to finalizing installation. Streamline is not responsible for defects and problems discovered or that could have been repaired or avoided by following this step.
- While tempered glass is stronger than regular glass, it is not indestructible. Even a minor scratch or contact with a hard surface can weaken or break the glass. This may result in the tempered glass shattering into numerous small pieces without warning. This can occur in the moment of impact, or over time. If it does break, the glass will shatter loudly into an excess of small pieces, which reduces the risk of personal injury.
- Ensure that the end user of the shower door is aware of the proper usage of the shower door as well as its maintenance.
- Exerting excessive force when opening or closing the slider can result in damage to the glass, potentially causing it to break. Gently guide the door back to its open or closed position to avoid damage from occurring.



IT IS CRUCIAL TO REVIEW ALL PROVIDED INSTRUCTIONS AND WARNINGS THOROUGHLY. FAILURE TO COMPLY WITH THESE INSTRUCTIONS AND WARNINGS MAY LEAD TO SEVERE INJURY OR EVEN LOSS OF LIFE DUE TO MISHANDLING OR IMPROPER INSTALLATION OF THE PRODUCT.

TO ENSURE A SAFE INSTALLATION, IT IS IMPERATIVE TO ADHERE TO THESE INSTRUCTIONS. FOR THE INSTALLATION PROCESS, IT IS MANDATORY TO ENGAGE A PROFESSIONAL INSTALLER WHO IS LICENSED AND INSURED. THE INSTALLATION REQUIRES THE PRESENCE OF TWO INDIVIDUALS.

UNDER NO CIRCUMSTANCES SHOULD ANY ALTERATIONS OR MODIFICATIONS BE MADE TO THE PRODUCT. ANY MODIFICATION TO THE PRODUCT WILL LEAD TO SEVERE INJURIES OR, IN SOME CASES, EVEN FATAL CONSEQUENCES.

THIS MANUAL AND ITS CONTENTS, INCLUDING BUT NOT LIMITED TO TEXT, IMAGES, GRAPHICS, AND INSTRUCTIONS, ARE PROTECTED BY COPYRIGHT AND TRADEMARK LAWS. NO PART OF THIS MANUAL MAY BE REPRODUCED, DISTRIBUTED, OR TRANSMITTED IN ANY FORM OR BY ANY MEANS, ELECTRONIC OR MECHANICAL, INCLUDING PHOTOCOPYING, RECORDING, OR BY ANY INFORMATION STORAGE AND RETRIEVAL SYSTEM, WITHOUT THE PRIOR WRITTEN PERMISSION OF STREAMLINE.

ALL PRODUCT NAMES, LOGOS, AND BRANDS ARE THE PROPERTY OF THEIR RESPECTIVE OWNERS. STREAMLINE RETAINS ALL RIGHTS TO ITS TRADEMARKS, TRADE NAMES, AND COPYRIGHTED MATERIALS ASSOCIATED WITH THIS PRODUCT. UNAUTHORIZED USE OF THESE MATERIALS IS STRICTLY PROHIBITED AND MAY RESULT IN LEGAL ACTION.

2. Tools Required

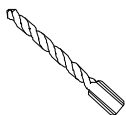

Drill Bits

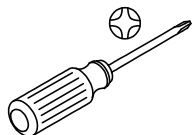

Screw Driver

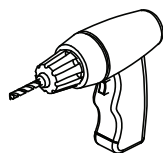

Drill

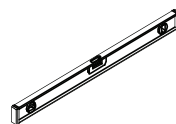

Level

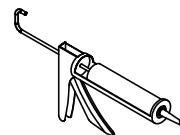

Silicone

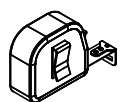

Measuring Tape

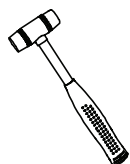

Soft Head Hammer

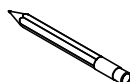

Pencil

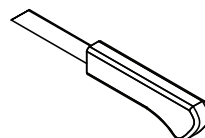

Knife

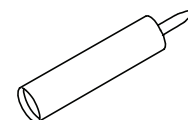

Sealant



Masonry Drill Bit For Tile



Safety Glasses



Gloves

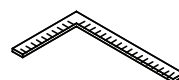

Carpenter's Squarer

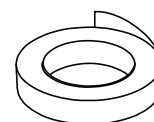

Masking or Painter's Tape

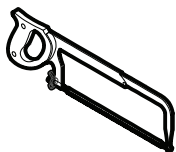

Hack Saw

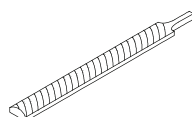

Metal File

3. Parts Diagram

Door Assembly

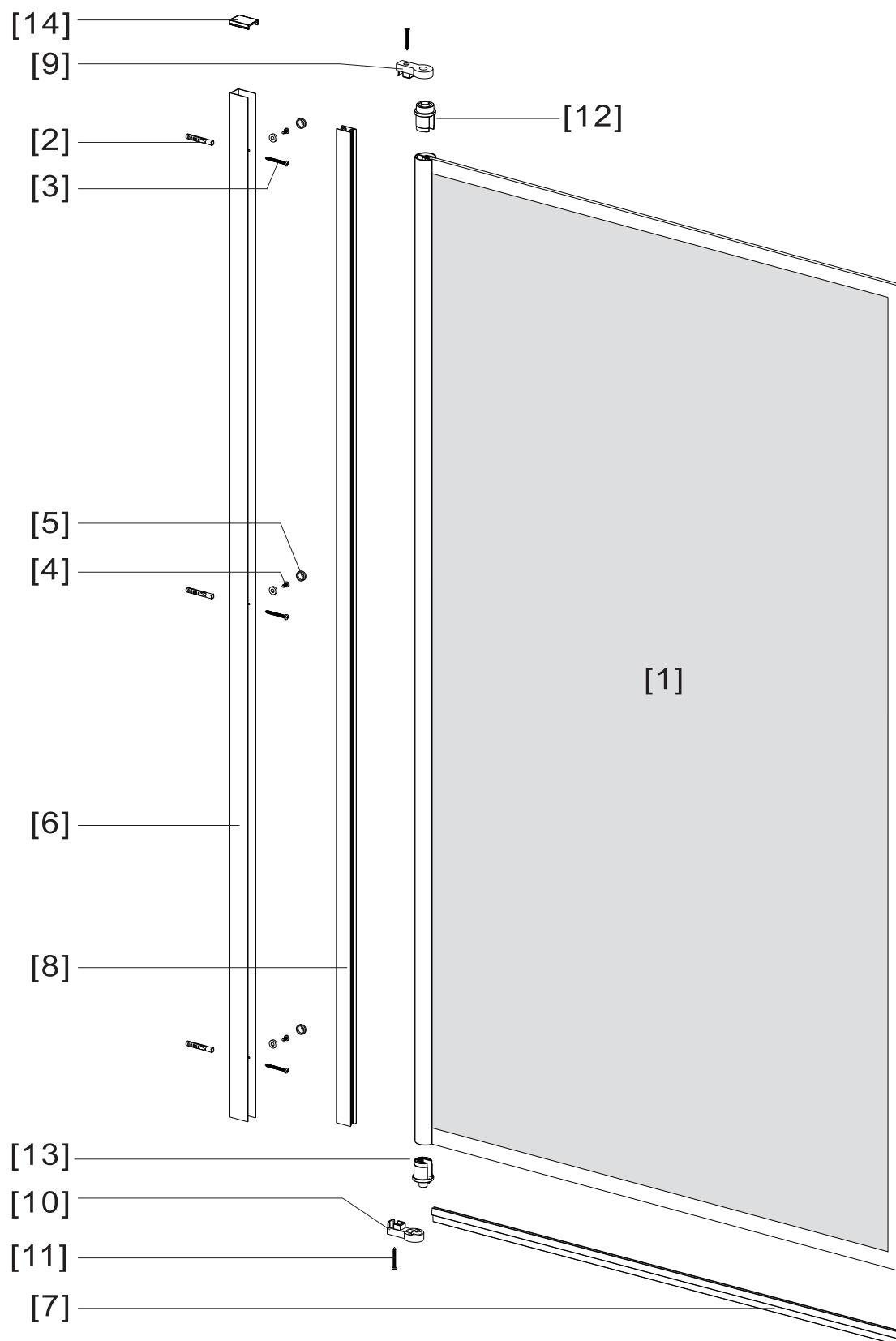

[1]



X1

[2]



X3

[3]

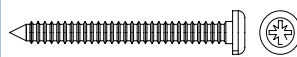

ST 3.5X32

X3

[4]

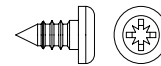

ST 3.5X9.5

X3

[5]

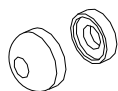

X3

[6]

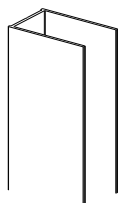

X1

[7]

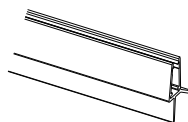

X1

[8]

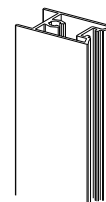

X1

[9]

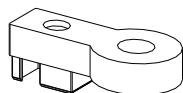

X1

[10]

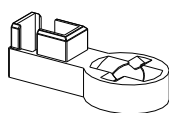

X1

[11]



ST 3.5X25

X2

[12]

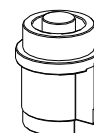

X1

[13]



X1

[14]

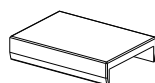

X1

Note: Inspect all parts prior to installation! Contact our support team if any parts are missing.

4.

Installation

Prior To Installation

This model is reversible for right or left-hand installation. The installation will be shown with stationary glass to the left of the enclosure. For installation of the glass to the right of the enclosure, simply begin on the opposite wall and reverse the orientation of the installation steps shown below.

Out of Plumb Adjustability: 2/5"

Minimum threshold: 1 1/16"



Please take note of the following important information:

On each glass panel, you will find a certification stamp accompanied by the Streamline logo. This stamp serves as proof that the glass is tempered for safety purposes. We strongly advise installing the panels with the markings positioned at the bottom corner nearest to the wall, where they are less conspicuous. It is crucial to understand that these markings cannot be removed.

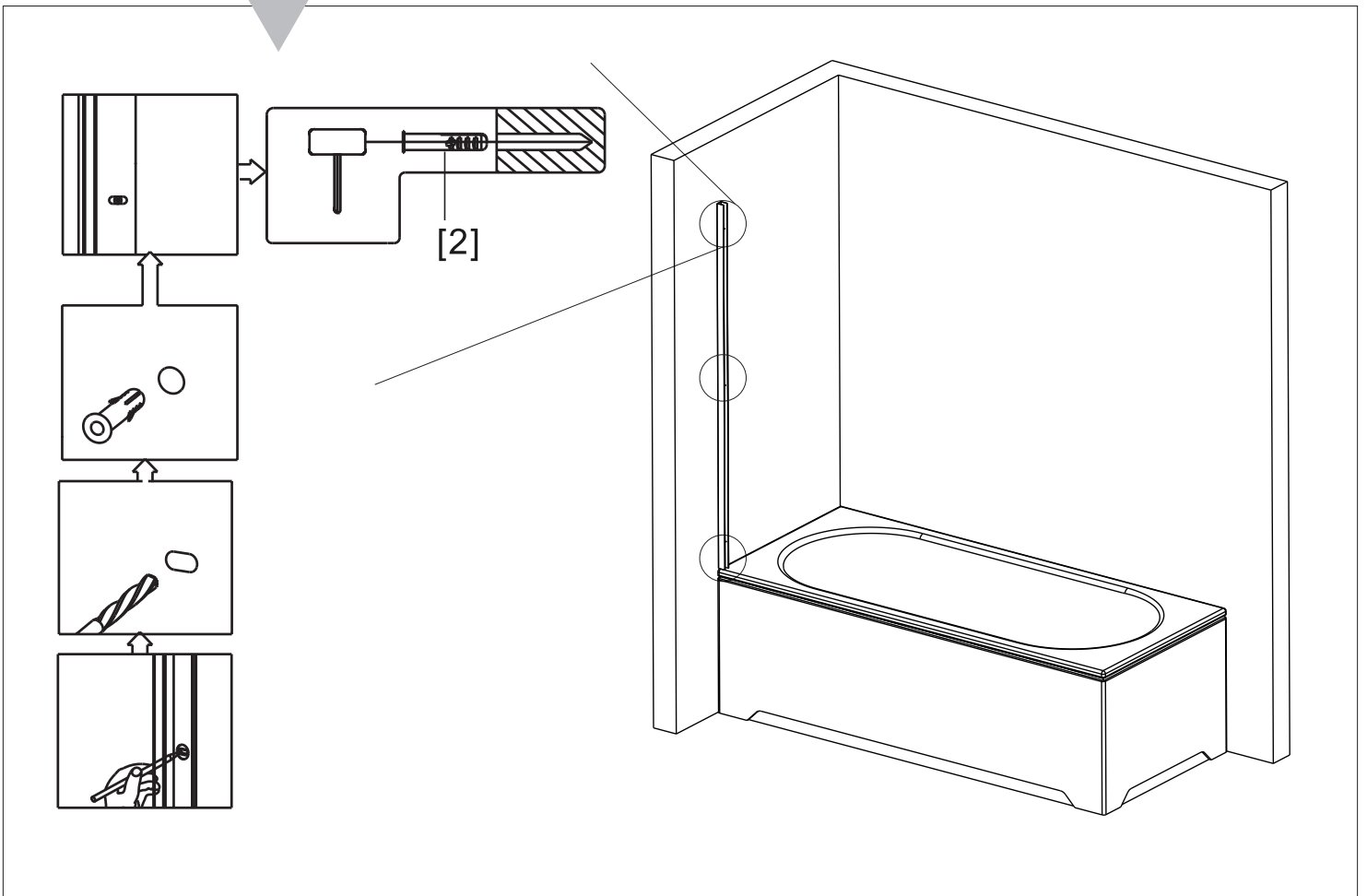
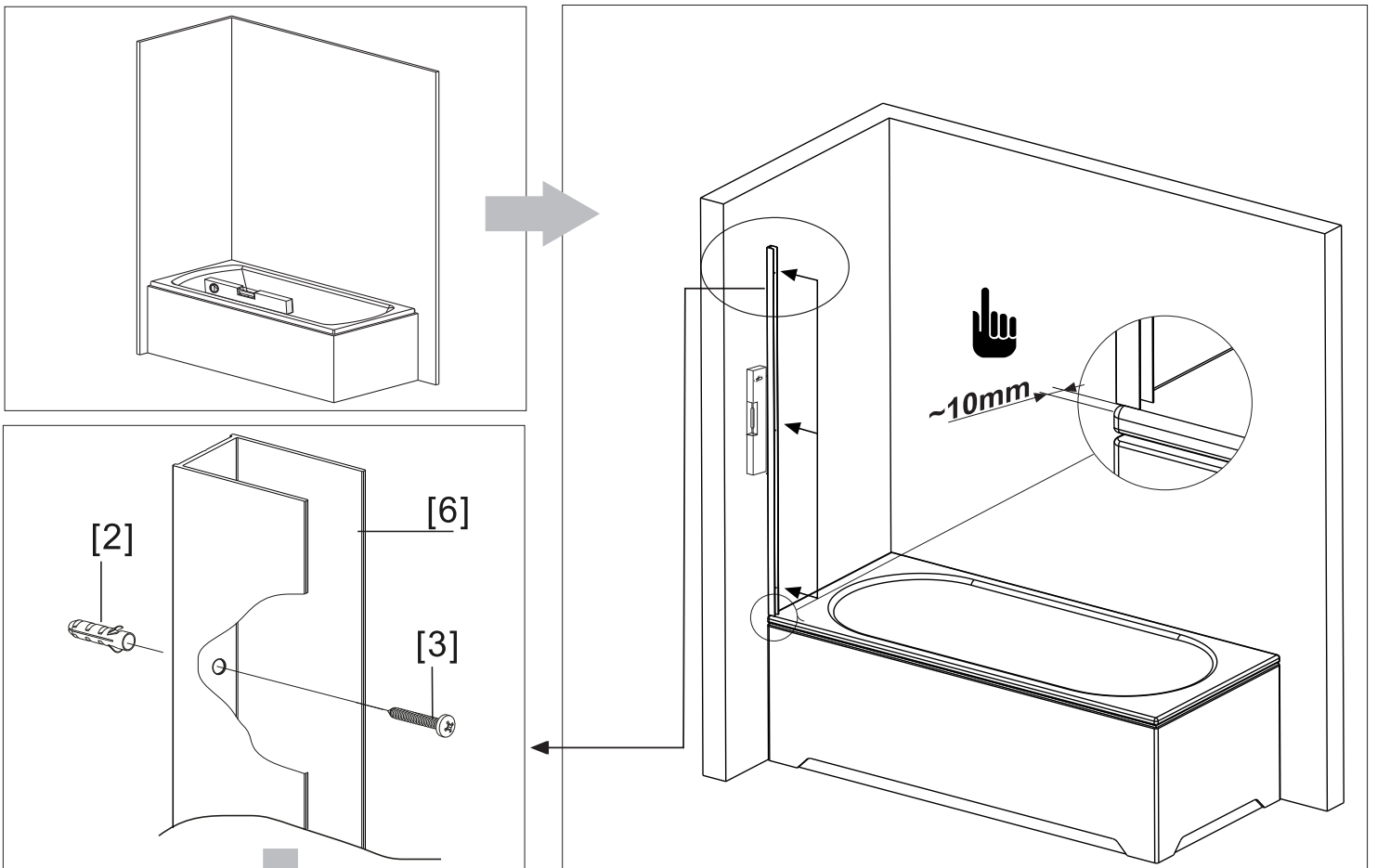

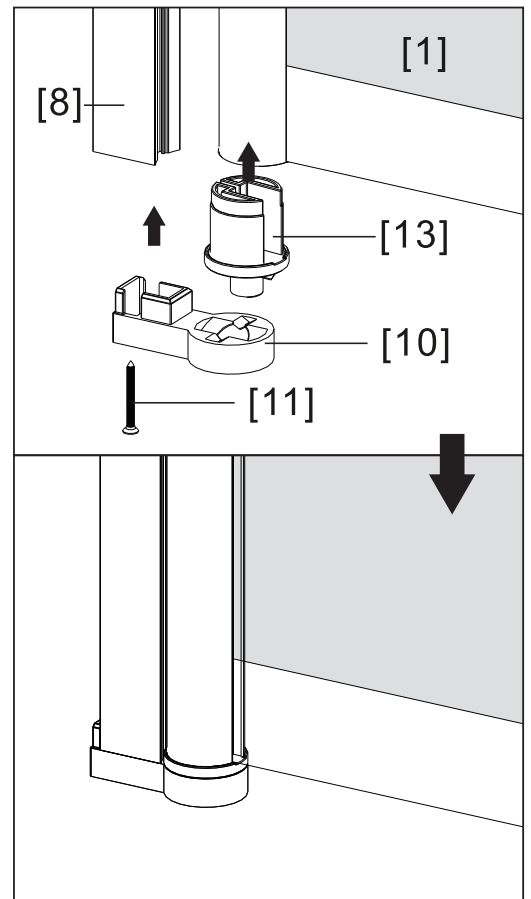
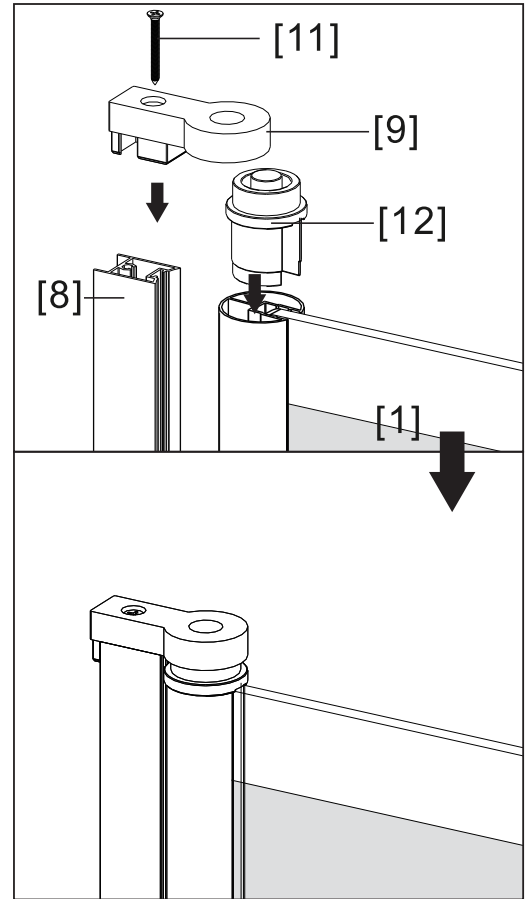
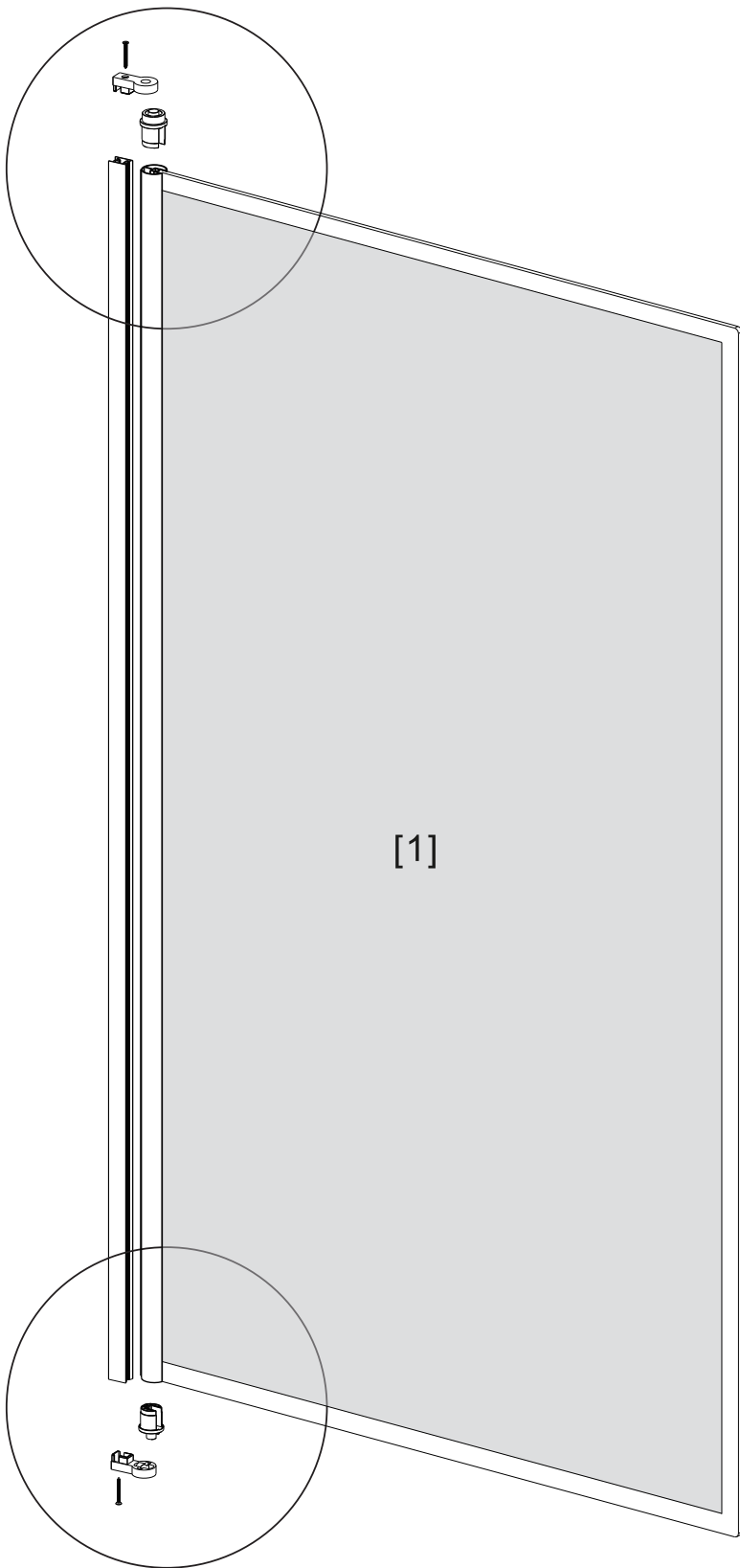

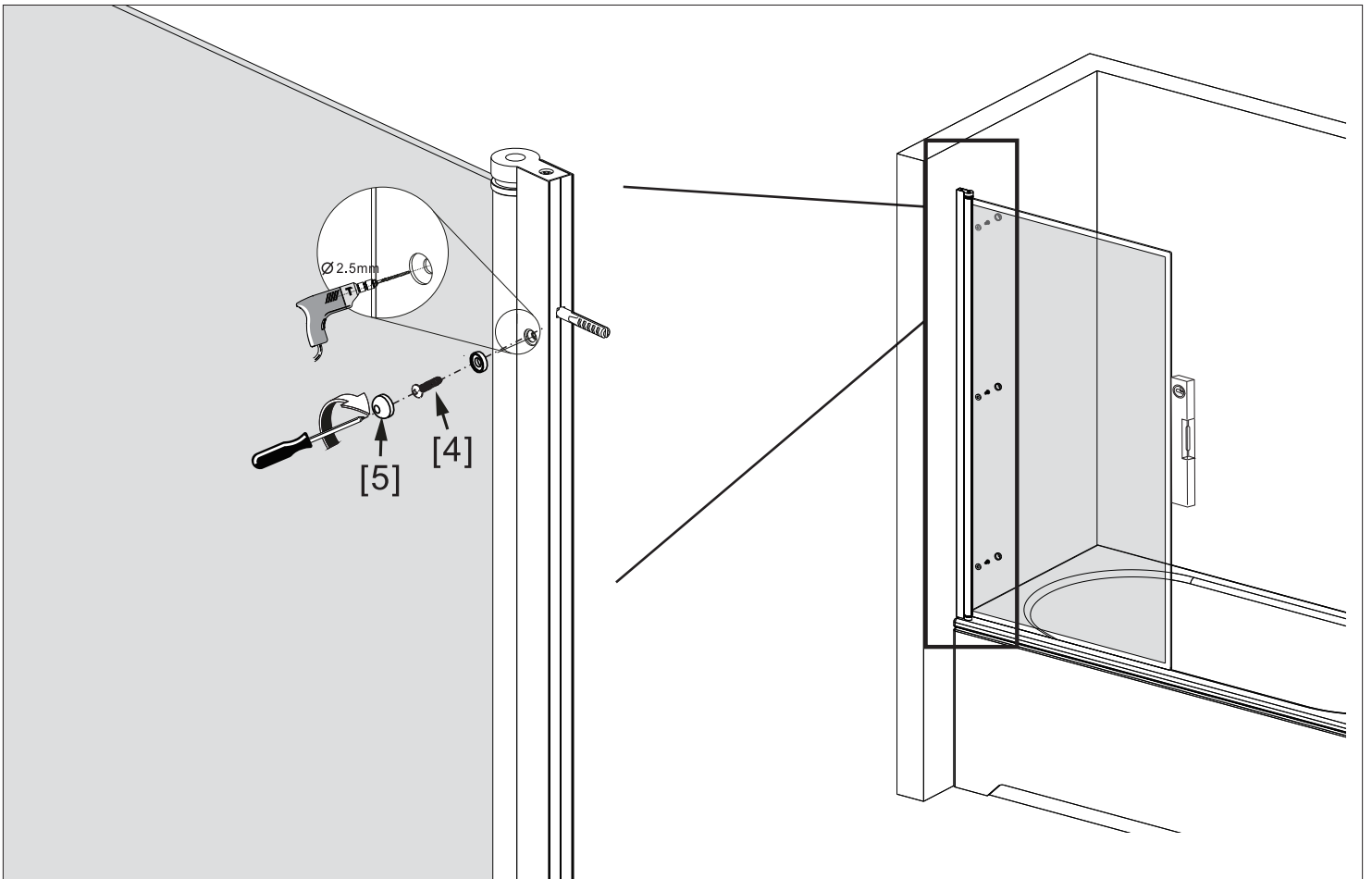
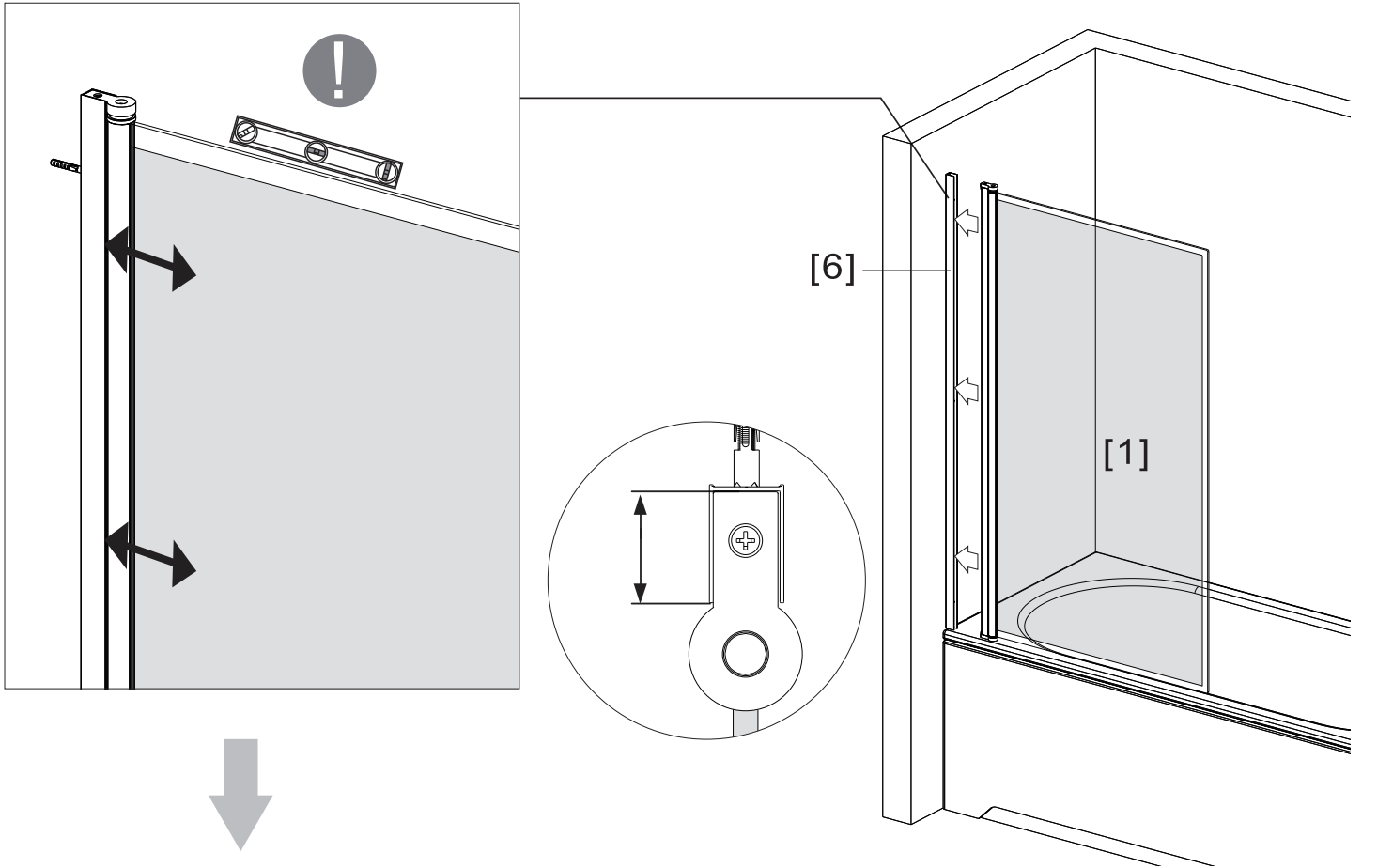

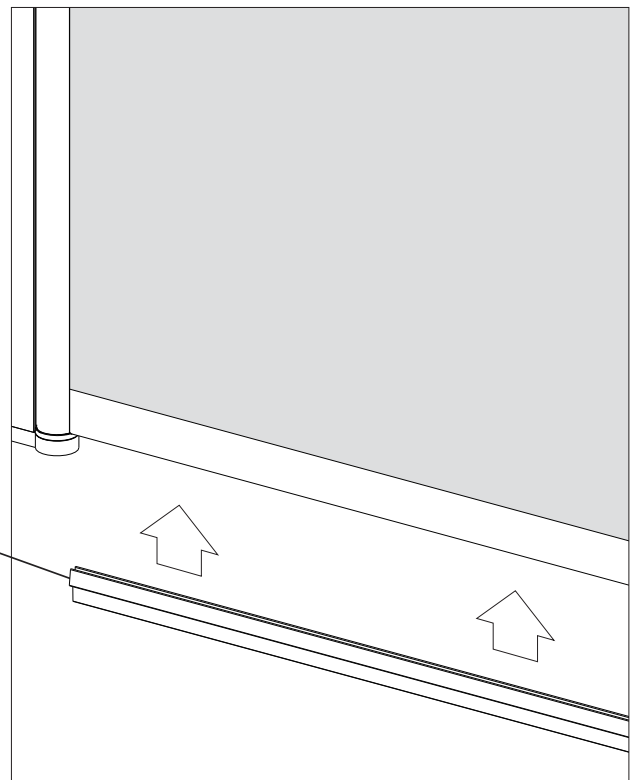
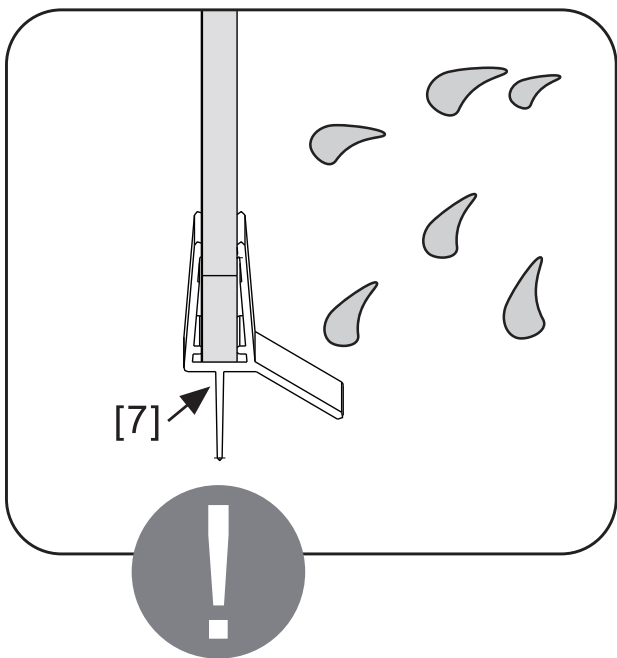
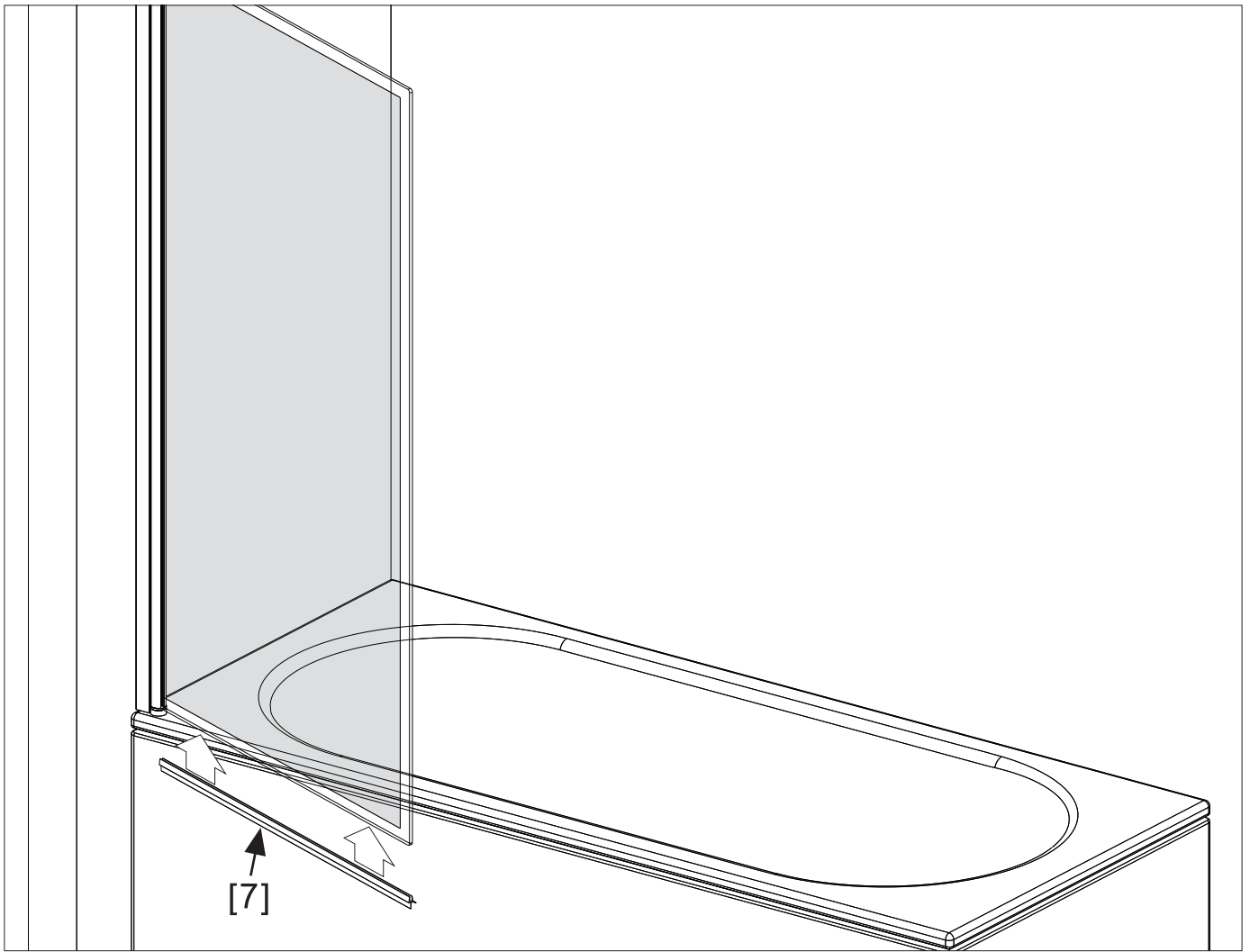

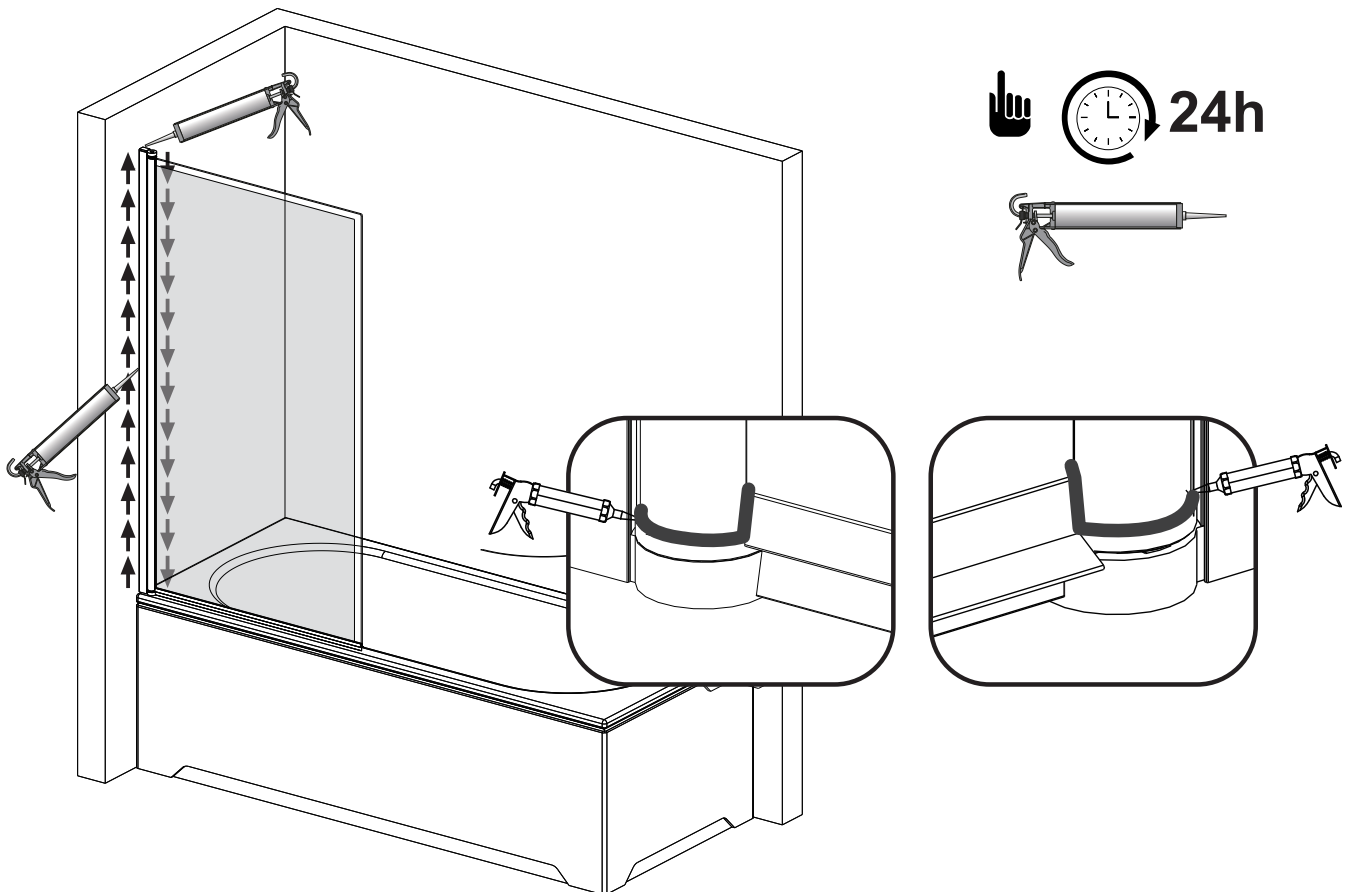
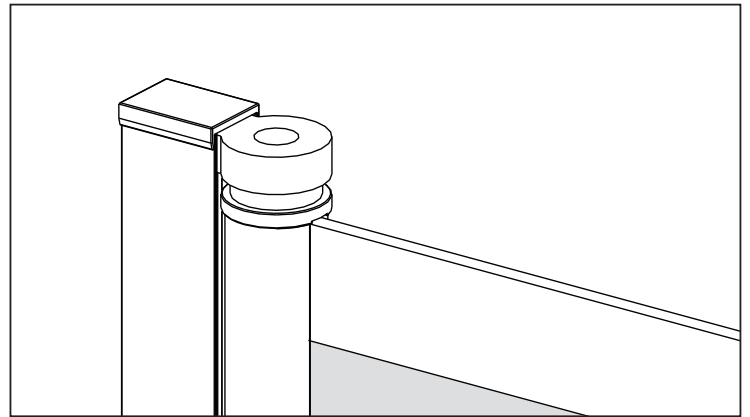
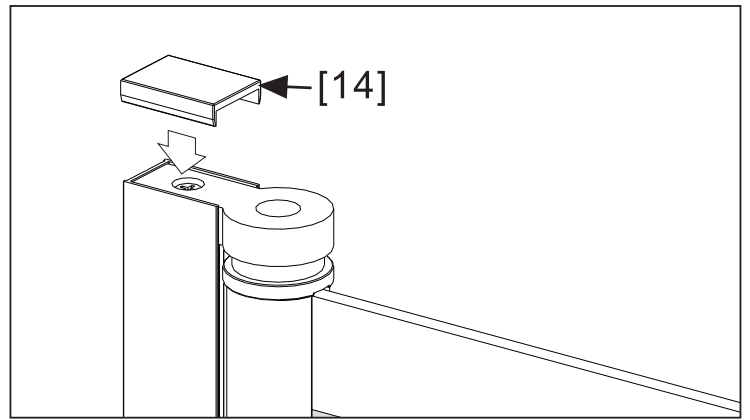
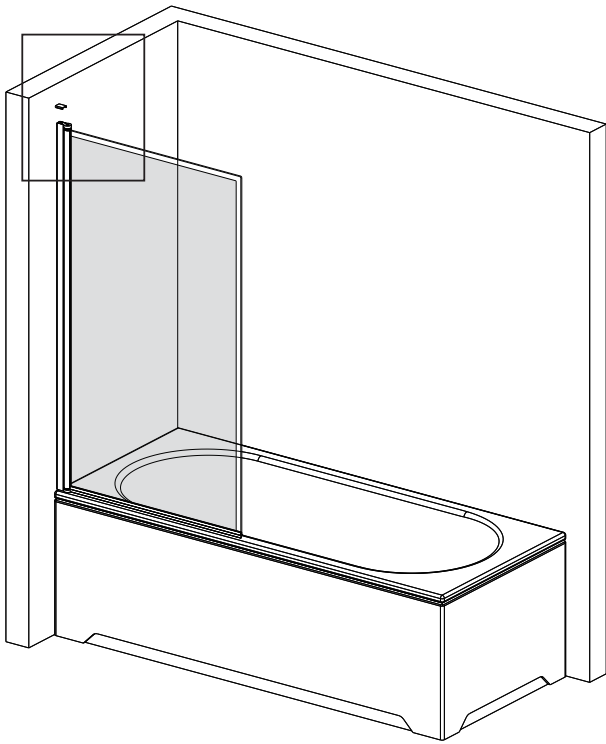

Product Care

This shower door has been treated with CrystalTech™, a coating that provides numerous benefits for its maintenance. The CrystalTech™ coating creates a protective barrier on the shower door, effectively repelling water and preventing the formation of water spots and mineral deposits. Users can enjoy a cleaner and clearer shower door without frequent and labor-intensive cleaning. While the CrystalTech™ treatment significantly reduces maintenance requirements, it is important to note that some upkeep is still necessary.

To ensure the long-lasting effectiveness of the coating, it is recommended to follow the instructions in the next section on how to maintain the shower door properly. By adhering to these instructions, users can preserve the benefits of CrystalTech™ and maintain a beautiful and spotless shower door for years to come.

To keep your glass shower door looking clean, it's advisable to use a squeegee and remove any water droplets daily. This practice can help prevent the buildup of hard water deposits and soap scum, which can dry and accumulate on the surface.



You can also use a microfiber cloth to clean the shower door and hardware, which is ideal for reaching difficult areas and wiping away any remaining water droplets.

If you live in an area with high levels of magnesium and calcium minerals in the water, it is recommended to utilize cleaning solutions specifically designed to tackle hard water stains when treating your shower door.

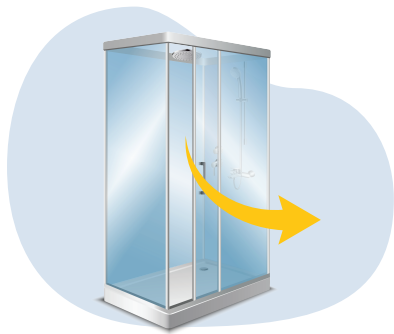

Ensure your shower door stays dry to avoid mildew or mold growth caused by trapped moisture. To promote proper drying, leave the glass door open after showering and run a fan or dehumidifier.

To maintain your shower door on a weekly basis, you can prepare a solution by combining vinegar and water in a ratio of 1:4. Add a few drops of mild dishwashing liquid to the mixture. Transfer the solution into a spray bottle and apply it to the shower doors. Allow the solution to sit for a short period, and then wipe the doors clean using a cloth or sponge.



It is important to refrain from using abrasive cleaning supplies, pads, steel, or wool. Likewise, it is recommended to avoid any cleaning products that contain bleach or ammonia.

To remove hard water stains and soap residue from your glass shower doors, make a paste by combining equal parts of distilled white vinegar and baking soda. This non-abrasive scrub is safe to use on the glass. Allow the mixture to dissolve a bit before applying it to the stains. Use a damp microfiber cloth or sponge to scrub the affected area.

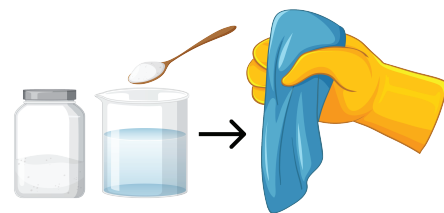

To effectively clean the shower door tracks, you can make a cleaning solution by combining equal parts vinegar and water. Spray the solution onto the shower door tracks, ensuring thorough coverage. Then, take an old toothbrush and gently scrub the tracks, focusing on areas with built-up grime or dirt. Afterward, use a microfiber cloth to wipe and dry the tracks, removing any remaining residue.

If you observe signs of rot or rust in the shower door tracks that cannot be adequately addressed through cleaning, seek the assistance of a professional for a shower remodel.

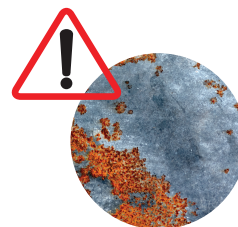

Using harsh cleaners can lead to corrosion of the hardware's finish.

Regularly check for any signs of loosening nuts, hinges, or bolts caused by regular use, and carefully inspect all hardware. Tighten and adjust as necessary to ensure everything remains secure and in proper working condition.

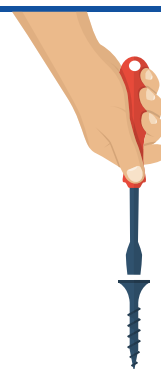



The seals on your glass shower door have an essential function in preventing water leakage onto the bathroom floor. Over time, these seals may experience wear due to friction; however, they are designed to be replaceable. To avoid any potential damage, it is advisable to clean the seals with mild soap and warm water rather than harsh chemicals. Additionally, it is vital to promptly replace any seals that display signs of wear or damage to ensure optimal performance.

The use of harsh chemicals can result in the formation of holes and leaks in the seals. To enhance the durability of the bottom sweep, which undergoes significant wear and tear, it is crucial to maintain its cleanliness and apply a coat of petroleum jelly to its surface.





Streamline

Our warranty program is designed to provide you with peace of mind. It covers a wide range of potential issues that may arise during the specified warranty period, ensuring that you can enjoy your shower door with confidence.

We are pleased to inform you that by purchasing our shower door, you are automatically enrolled in our warranty program.

We want to assure you that our warranty program is backed by our commitment to quality and customer satisfaction. In the unlikely event that you encounter any concerns or defects with your shower door, our dedicated support team is here to assist you promptly and efficiently.

Please take a moment to review the details of your warranty coverage, which can be found in the documentation included with your purchase. If you have any questions or require further clarification, do not hesitate to contact our customer service department. We are always ready to provide the assistance you need.

Once again, thank you for choosing our shower door and for allowing us to serve you. We value your trust and are committed to delivering the highest level of product quality and customer care. We look forward to exceeding your expectations throughout your ownership of our shower door.

For any questions or comments about your new shower door, please contact customer service at:

USA:

(310) 935-0028

support@streamlinebath.com

Canada:

(604) 757-6589

support@streamlinebath.com

LIMITED WARRANTY EXCLUSION

ALL OTHER WARRANTIES EXPRESS OR IMPLIED INCLUDING ALL IMPLIED WARRANTIES OF MERCHANTABILITY OF FITNESS FOR A PARTICULAR PURPOSE ARE HEREBY DISCLAIMED. STREAMLINE® IS NOT LIABLE FOR ANY INDIRECT, PUNITIVE, INCIDENTAL, CONSEQUENTIAL, SPECIAL OR SIMILAR DAMAGES INCLUDING, BUT NOT LIMITED TO, TIME AWAY FROM WORK, HOTELS AND/OR RESTAURANT MEALS, REMODELLING EXPENSES IN EXCESS OF DIRECT DAMAGES WHICH ARE DEFINITELY CAUSED EXCLUSIVELY BY STREAMLINE®, LOST PROFITS OR REVENUE, INABILITY TO USE THE PRODUCT, OR ANY OTHER ASSOCIATED EQUIPMENT, THE COST OF SUBSTITUTE EQUIPMENT, AND ANY CLAIMS BY THIRD PARTIES RESULTING FROM THE USE OF THIS PRODUCT.

UNDER NO CIRCUMSTANCES SHALL STREAMLINE'S LIABILITY EXCEED THE PURCHASE PRICE OF THE UNIT.

STREAMLINE® PRODUCTS MUST BE INSTALLED BY A FULLY INSURED, LICENSED, PROFESSIONAL WHO SHALL FOLLOW THE INSTRUCTIONS PROVIDED BY STREAMLINE®. SHOULD THE PRODUCT BE INSTALLED BY AN INDIVIDUAL WHO IS NOT A FULLY INSURED, LICENSED PROFESSIONAL, THIS SHALL VOID THE WARRANTY OF THE PRODUCT.

SHOULD A WARRANTY CLAIM ARISE AND EITHER PARTS, REPLACEMENT, OR REPAIR OF THE STREAMLINE PRODUCT IS NECESSARY, FULFILLING THE INITIAL WARRANTY CLAIM SHALL DISCHARGE STREAMLINE® OF ANY FUTURE WARRANTY OBLIGATION. IF THE PURCHASER REFUSES THE WARRANTY SOLUTION PROVIDED BY STREAMLINE®, THIS ACT SHALL VOID THE WARRANTY. UNDER BOTH INSTANCES, STREAMLINE® WILL NOT BE HELD RESPONSIBLE FOR ANY COSTS ASSOCIATED WITH SERVICING THE WARRANTY

NO PERSON MAY MAKE ANY REPRESENTATION, AFFIRMATION, OR WARRANTY OTHER THAN THOSE CONTAINED IN THIS WARRANTY. ANY AFFIRMATION, REPRESENTATION OR WARRANTY BY ANY PERSON WHO IS NOT A STREAMLINE® EMPLOYEE SHALL NOT BE ENFORCEABLE AGAINST STREAMLINE®

Streamline® makes no representations about the quality, durability, or need for service or repair of its products other than the representations contained in this warranty. If you want a longer or more comprehensive warranty than the limited warranty that comes with this product, you should ask Streamline® or your retailer about buying an extended warranty. This warranty gives you specific legal rights, and you may have other rights that vary from state to state. Some states do not allow the exclusion or limitation of incidental or consequential damages, and some states do not allow limitations on how long an implied warranty lasts, so the limitations or exclusions stated above may not apply and may vary from state to state.

The warranties stated herein apply only to the first purchaser of the Product and are not transferable. Streamline® reserves the right to request proof of purchase at the time any warranty claim is submitted to confirm that the Product falls within the scope of this limited product warranty.

OUT OF WARRANTY PRODUCT

STREAMLINE® IS UNDER NO OBLIGATION, AT LAW OR OTHERWISE, TO PROVIDE YOU WITH ANY CONCESSIONS, INCLUDING REPAIRS, PRORATES,

LIMITED MANUFACTURER'S WARRANTY

All parts and finishes of Streamline® products are warranted to the original consumer purchaser to be free from defects in material and workmanship for a period of two to five years [depending on the product and model; please check the product listing or email us at support@streamlinebath.com if you are unsure] after the date of original retail purchase. Proof of the original purchase is required to obtain a remedy under this limited warranty. Streamline® recommends using a certified professional for all installation and repair of kitchen and bathroom fixtures.

Streamline® will replace, free of charge, during the warranty period any part or finish that proves defective in material and/or workmanship under normal installation, use and service. Replacement parts may be obtained by emailing us at support@streamlinebath.com

This warranty is extensive in that it covers replacement of all defective parts and even finish, but these are the only two things that are covered. Labor charges and/or damage incurred in installation, repair, or replacement as well as any other kind of loss or damages are excluded. Proof of purchase (original sales receipt) from the original consumer purchaser must be made available to Streamline® for all warranty claims. This is the exclusive warranty by Streamline®, which does not make any other warranty of any kind, including the implied warranty of merchantability. This warranty excludes all industrial, commercial and business usage, whose purchasers are hereby extended a one-year limited warranty from the date of purchase, with all other terms of this warranty applying except the duration of the warranty.



WHAT IS NOT COVERED UNDER THIS LIMITED WARRANTY

- Normal wear and tear, spills of food, liquid, grease accumulations or cosmetic damage.
- Damage due to accidents, misuse, physical force, improper installation or operation, mishandling, neglect, fire, heat, water, humidity, liquids, insect infestation, or other intrusion.
- Products that have been repaired, altered or modified by anyone other than Streamline® or its authorized service representative.
- Damage caused by use of non-Streamline® accessories or misapplication.
- Products whose serial numbers have been removed, altered or rendered illegible.
- Products purchased, shipped from, used or serviced outside the United States, Canada, and Mexico.
- Damage caused by acts of nature such as, but not limited to, lightning damage.
- Products returned without valid proof of purchase.
- Consumable parts such as light bulbs, metal, and charcoal filters.
- Any party's willful misconduct, negligence, misuse, abuse, accidents, neglect, improper operation, failure to maintain, improper or negligent installation, tampering, failure to follow operating instructions, mishandling, unauthorized service (including self-performed "fixing" or exploration of the product's internal workings).
- Use of corrosive or abrasive cleaning products.
- Cosmetic damages including scratches, dents, chips and other damage, unless such damage results from defects in materials and workmanship and is reported to Streamline within 3 calendar days of delivery.
- Use of the Product in anything other than its normal, customary and intended manner.
- A failure to comply with any applicable state, local, city or county electrical, plumbing and/or building codes, regulations, or laws, including failure to install the product in strict conformity with local fire and building codes and regulations.
- In no event shall Streamline have any liability or responsibility whatsoever for damage to surrounding property, including cabinetry, floors, ceilings, and other structures or objects around the product.

NO ATTEMPT TO ALTER, MODIFY, OR AMEND THIS WARRANTY SHALL BE EFFECTIVE UNLESS AUTHORIZED IN WRITING BY AN OFFICER OF STREAMLINE.